

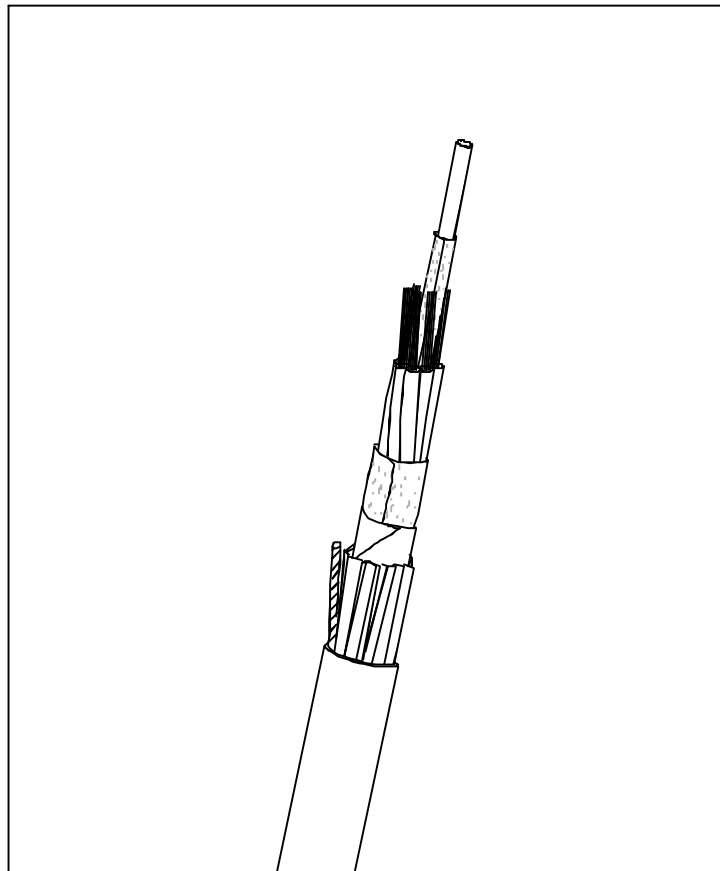

**Cable Access Procedures For Outside Plant  
Reverse Oscillating Lay (ROL) FlexLink™, OptiLink™,  
MiniLink™ and MassLink™ Loose Tube Dri-Flex™ Cables  
Armored or Dielectric  
Single Fiber, Bundled Fiber or Ribbon  
End and Mid-Span**



MP - 1001  
Issue #8  
October 5, 2010



## **DISCLAIMER OF WARRANTIES AND LIMITATION OF LIABILITIES**

The practices contained herein are designed as a guide. Since there are numerous practices which may be utilized, Prysmian has tested and determined that the practices described herein are effective and efficient. The recommended practices are based on average conditions.

In addition, the materials and hardware referenced herein appear as examples, but in no way reflect the only tools and materials available to perform these evaluations.

Prysmian Communications Cables and Systems USA makes no representation of nor assumes any responsibility for its accuracy or completeness. Local, State, Federal and Industry Codes and Regulations, as well as manufacturers requirements, must be consulted before proceeding with any project. Prysmian Communications Cables and Systems USA disclaims any liability arising from any information contained herein or for the absence of same.

For further information or assistance, contact:

Prysmian Communications Cables and Systems USA  
Field Services Department  
700 Industrial Drive  
Lexington, SC 29072-3799  
803-951-4800  
FAX (803) 957-4628

OR

Prysmian Communications Cables and Systems USA  
Applications Engineering Department  
710 Industrial Dr.  
Lexington, SC 29072-3799  
803-951-4800  
FAX (803) 951-4044



**Cable Access Procedures For Outside Plant  
Reverse Oscillating Lay (ROL) FlexLink™, OptiLink™  
MiniLink™ and MassLink™ Loose Tube Dri-Flex™ Cables**

- Dielectric or Armored**
- Single Fiber in Loose Tube (FlexLink™ and MiniLink™)**
- Bundled Fiber in Loose Tube (OptiLink™)**
- Ribbon in Loose Tube (MassLink™)**
- End or Mid-span Access**

**MP – 1001, Issue 6**

**Table of Contents**

	Page
1.0 General Information	4
2.0 Preparation Notes - Tools and Materials	4
3.0 Procedures for End Access	5
3.1a Dielectric Sheath Removal	5
3.1b Armored Sheath Removal	6
3.2 End Access Core Preparation	7
3.3 End Access Buffer Tube Preparation	8
4.0 Procedures for Mid-Span Access	8
4.1 Location of Mid-Span	8
4.2a Dielectric Sheath Removal	9
4.2b Armored Sheath Removal	10
4.3 Mid-Span Access Core Preparation	11
4.4 Mid-Span Access Buffer Tube Preparation	12
5.0 Ribbon Cleaning	12
6.0 Ribbon Preparation	13
6.1a End Preparation: Thermal-Mechanical	13
6.1b End Preparation: Mechanical	14
6.2 Mid-span Preparation	14
7.0 Bundle Fiber Preparation	15
8.0 Fiber Preparation	15

## 1.0 GENERAL INFORMATION

This instruction manual is a step-by-step guide for end and mid-span access of Prysmian's Reverse Oscillating Lay Loose Tube Dri-Flex™ Cables, including sheath removal, core preparation, and fiber preparation. Local company practices and/or vendor specifications may be in place concerning cable access and how it relates to a specific product or application. Modifications that do not exceed the cable's optical and mechanical performance specifications may be made to accommodate local company practices and specifications. These modifications should be made at the discretion of local company users. Illustrations have been provided for your reference and orientation as you follow the procedures.

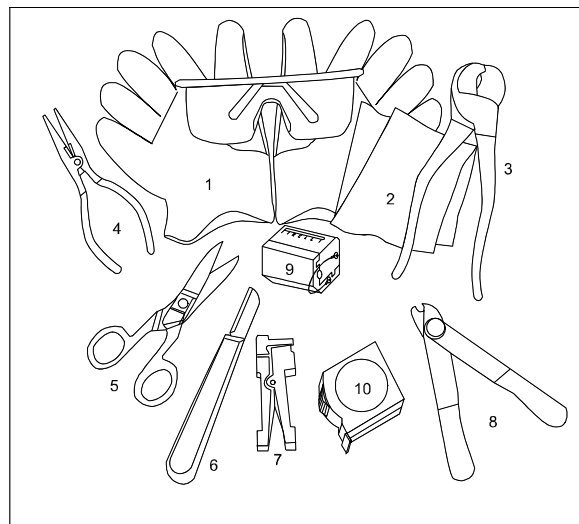

(Figure 2.0a) Tools and Materials

## 2.0 PREPARATION NOTES

Gather the appropriate tools and materials to be used for the job, ensuring they are approved for use by your company and are in good working order. For future reference, record the cable identification markings, which consist of sheath number, footage, and cable description codes printed on the cable outer sheath. A sample SOCC code printed cable is provided below. Printed information may vary per company request.

1. Eye and Hand Protection
2. Clean Cotton Cloths
3. Approved Cable Cutters
4. Needle Nose Pliers
5. Scissors/Snips
6. Sheath Knife
7. Buffer Tube Removal Tool (end access)
8. Primary Coating Stripping Tool
9. Buffer Tube Slitter (mid-span access)
10. Tape Measure

Date manufactured _____ Fiber Count _____ Number of fibers per Unit _____ Fiber Unit Configuration in Core _____ Tensile Rating _____ Sheath Description _____ Performance @ 1310 nm _____ Fiber Type/Wavelength _____ Manufacturer _____	
=  PRYSMIAN OPTICAL CABLE PC-34X2LT-012 01-08 =	
= 75152 =	= 1346 FEET =
 Sheath Number	 Sequential Length Marking

### 3.0 PROCEDURES FOR END ACCESS

This procedure is for all Reverse Oscillating Lay Loose Tube Dri-Flex™ cables, armored or dielectric (non-armored). The length of the cable sheath to be removed will depend on local company practices and termination equipment. If not otherwise specified, 6 feet (2m) should be sufficient.

#### 3.1a Dielectric Sheath Removal

With the sheath knife, “ring” the circumference of the sheath at the prescribed distance from the end of the cable. Take care not to cut too deeply and damage the ripcords and strength yarns underneath the sheath.

Now ring the outer sheath with the sheath knife 4 to 6 inches from the cable end, using the same method and precautions explained in the previous paragraph.

Flex the cable at the ring cut to separate the sheath.

Remove and discard the cable end sheath section to expose the ripcords.

Grasp and wrap one of the ripcords around the needle nose pliers and pull back to the first ring-cut. Repeat this process for the second ripcord.

Remove the split sheath from the cable by holding the cable straight and pulling on the sheath. Discard the sheath and proceed to step 3.2 for core preparation.

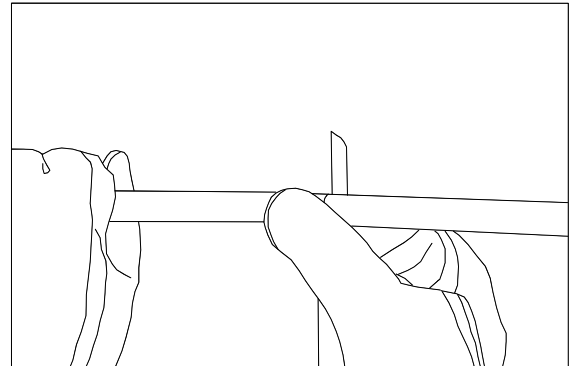

(Figure 3.1.a) Ring the outer sheath with a sheath knife

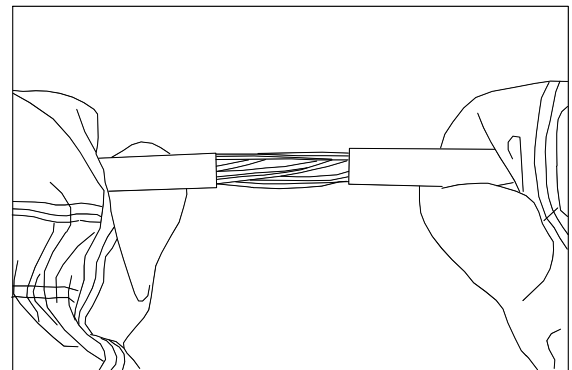

(Figure 3.1.b) Remove the cable end sheath section

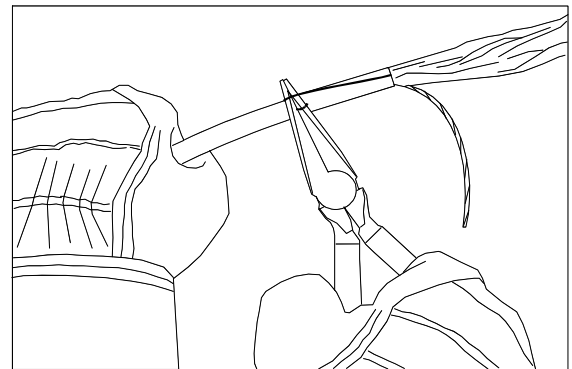

(Figure 3.1.c) Grasp and pull ripcord with needle nose pliers

### 3.1b Armored Sheath Removal

Armored sheath removal is similar to dielectric sheath removal. Using a sheath knife, ring cut the sheath at the appropriate distance from the end of the cable. When making ring cuts on armored cable, it is necessary to score the steel armor after cutting through the sheath. **DO NOT ATTEMPT TO CUT THROUGH THE STEEL AS YOU MAY DAMAGE THE CORE UNDERNEATH.** Once the steel is scored, flexing the cable should cause the armor to break cleanly along the scored line.

Now ring the outer sheath with the sheath knife 2 to 3 inches from the cable end. Score the steel as before and flex to break. Slide the sheath and armor off the cable to expose the ripcords and core or inner sheath.

Before pulling the ripcords, nick the armor with side cutters at the points where the ripcords disappear under the sheath. This gives a starting point for the ripcords to slit the armor

Grasp and wrap one of the ripcords around the needle nose pliers and pull back to one inch beyond the ring-cut. This will allow creation of a metal tab for proper bonding/grounding of the outer metallic shield. Repeat with the second ripcord to remove the sheath and armor. Discard the sheath and proceed to step 3.2 for core preparation.

Note: The edge of the metallic overlap can cause the ripcord to break. If this occurs, rotate the ripcord away from the overlap and continue the removal operation.

This paragraph assumes the cable is a Single Armor/Single Jacket design sheath. If the cable is a multiple sheath design, the inner polyethylene sheath or another sheath/armor layer will now be exposed. Simply follow the appropriate previous steps to remove the additional sheath(s) before proceeding to step 3.2 for core preparation.

If access to both sides of the metallic armor is required for the application of a grounding fixture, use a hot air gun to carefully heat the jacket. Once the jacket has softened use a sheath knife to easily remove the jacket material down to the armor. Then follow manufacturer's instructions for installing the fixture

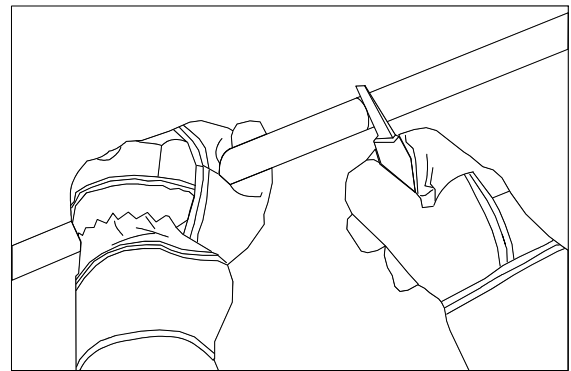

(Figure 3.1.d) Ring the outer sheath with a sheath knife

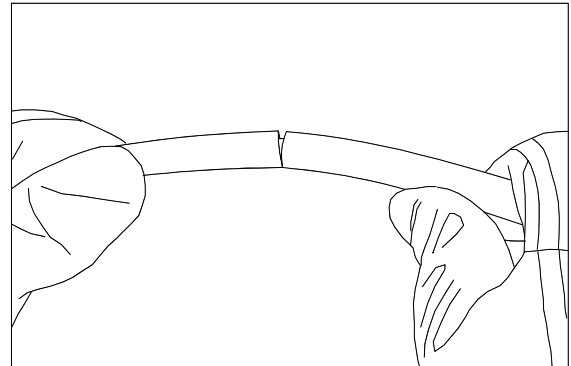

(Figure 3.1.e) Flex the cable at the ring cut

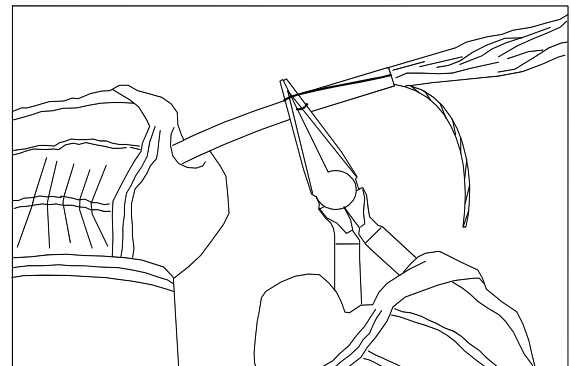

(Figure 3.1.f) Grasp and pull ripcord with needle nose pliers

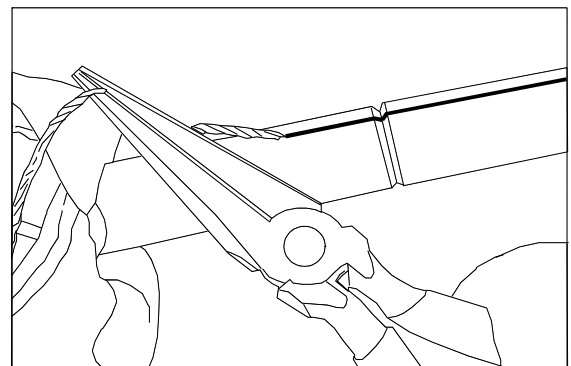

(Figure 3.1.g) Pull back ripcord to approximately 1 inch past ring cut to create grounding tab.

### 3.2 End Access Core Preparation

The cable core consists of color-coded buffer tubes stranded around a central strength member. The buffer tubes are secured by binder strings. Water absorbent tapes and yarns are wrapped around the buffer tubes and the central strength member. Outer strength member may be stranded around this assembly.

Cut the ripcords now that the proper lengths of tubes are exposed. If present, unwrap and cut to length the outer strength members as required by the splice closure or other termination hardware being used.

Unwrap and cut the water absorbent tapes, yarns and binder strings which are around the buffer tubes. Discard these materials.

Separate the color-coded buffer tubes from the central strength member by unwrapping the tubes one at a time. Remove any water absorbing tapes or yarns from around the central strength member and tubes.

Using approved cutters, cut the central strength member to the proper length for the type of closure or other termination hardware being used. The central member may be covered with a coating of plastic. This coating may need to be removed for a proper fit in the closure securing mechanism. To remove the coating, "ring" it with a sheath knife at the required distance from the end of the strength member. Do not cut into the underlying strength member. Using needle nose pliers, pull on the coating to separate it from the central member. It may be necessary to make a longitudinal cut in the coating from the ring cut to the end to facilitate the removal process.

If the cable contains tube placeholders, separate and cut them near the end of the sheath (placeholders may be solid filler tubes or dummy tubes without fiber).

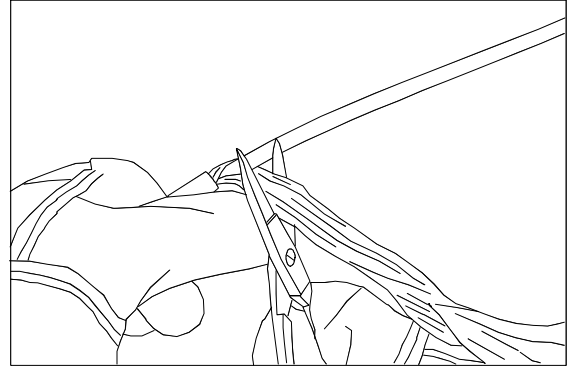

(Figure 3.2.a) Unwrap and cut outer strength members, water absorbent materials, and binders

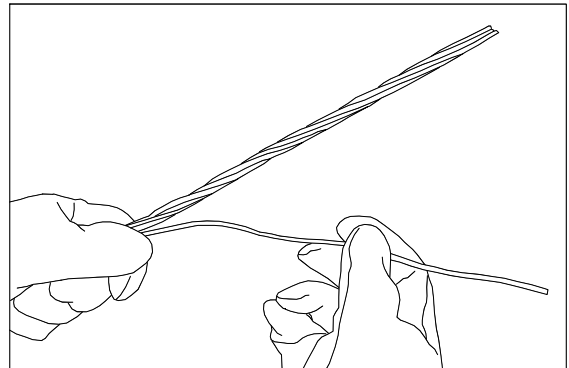

(Figure 3.2.b) Separate buffer tubes from central member.

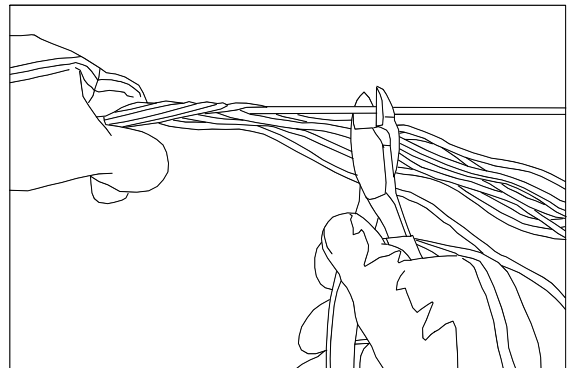

(Figure 3.2.c) Cut central member to proper length with cable cutters

### 3.3 Buffer Tube Preparation

Following the core preparation, check the blade setting on the buffer tube removal tool by “ringing” a small section near the end of the tube.

A proper depth setting will score the buffer tube, which, when gently flexed, will break at this point. This allows safe and easy access to the fiber or ribbons.

Measure the length of the tube to be removed and mark each tube. “Ring” the tube in 1 to 2-foot sections and remove them until the desired length of fiber or ribbons are exposed.

Gently wipe the excess thixotropic gel from the exposed fiber or ribbons with an approved lint free soft wipe. Repeat for the remaining tubes.

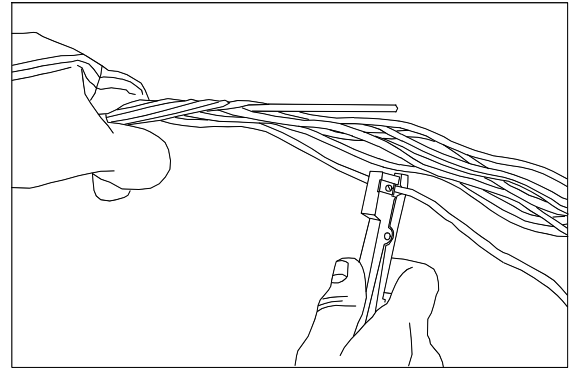

(Figure 3.3.a) Score buffer tubes with buffer tube removal tool

## 4.0 PROCEDURES FOR MID-SPAN ACCESS

### NOTE:

**Mid-Span Access is NOT applicable to Ribbon in Loose Tube (MassLink designs).**

This procedure is for all Reverse Oscillating Lay Loose Tube Dri-Flex™ cables, armored or dielectric (non-armored). The length of the cable sheath to be removed will depend on local company practices and termination equipment.



(Figure 3.3.b) Wipe excess thixotropic gel from the fibers or ribbons

### 4.1 Location of Mid-Span

Note: Centering the Mid-span Access on a Reversal Point of the Buffer Tube Reverse Oscillating Lay (ROL) is necessary to allow the greatest length of exposed buffer tubes to be unwound from the core.

A Buffer Tube reversal point is the location at which the helical twist reverses direction. By accessing a 40 inch (100 cm) section of cable, a reversal point should be found on any Prysmian loose tube cable. This reversal point should be centered in the sheath opening.

Higher fiber count loose tube cables (excluding ribbon) will be constructed with two layers of buffer tubes. Unwrapping the outer layer of tubes will expose the inner layer. Centering the outer layer of tubes within the length of removed sheath will provide the best access to the inner layer.

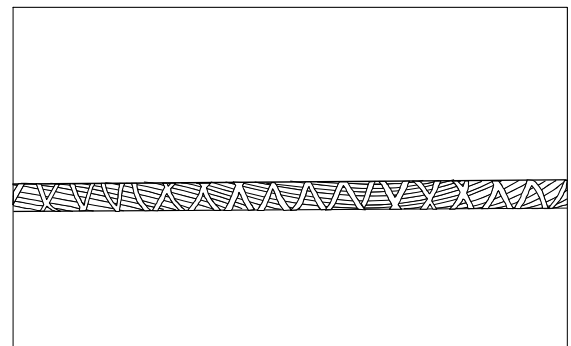

(Figure 4.1.a) Locate the buffer tube reversal point

## 4.2a Dielectric Sheath Removal

Place tape markers 40 inches (100 cm) apart from each other on the cable section to be accessed. With the sheath knife, “ring” the circumference of the sheath at both marks, taking care not to cut too deeply and damage the core or ripcords.

In the center of the 40 inch (100 cm) section, measure and mark off a 3 to 5-inch (8-13cm) span of the outer sheath. “Ring” the cable with the sheath knife at each mark. Use caution to avoid cutting the ripcord under the cable sheath.

Gently flex the cable at the ring cuts to separate the sheath.

Carefully shave or slit the outer sheath along the 3 to 5-inch (8-13 cm) section from one ring cut to the other using the sheath knife. Care must be taken to not damage the underlying buffer tubes or ripcords. The section can now be removed from the cable core and discarded.

With the outer sheath removed, the ripcords and cable core are exposed. Cut the ripcords in the center of the exposed section.

Grasp and wrap one of the ripcords around the needle nose pliers and pull back to the outside ring cuts. Do this in both directions. Repeat for the other ripcord and remove the split sheath from the cable.

Cut the outer strength members if present at the center of the section and secure them away from the core.

Unwrap, cut, and discard the water absorbent tapes and yarns which are around the buffer tubes. Leave the buffer tube binder strings and ripcords intact at this time.

Locate the buffer tube reversal point by scanning the exposed cable core (refer back to section 4.1) The reversal must be centered in the full mid-span access length. Repeat the previous steps to remove additional lengths of sheath, on either side of the reversal point, to expose the correct length of cable core. Refer to the closure documentation for specific lengths to be accessed. Proceed to Step 4.3 for Core Preparation.

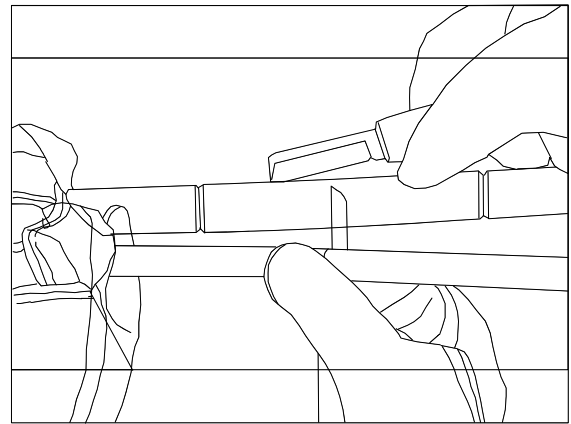

(Figure 4.2.a) Ring the outer sheath with a sheath knife

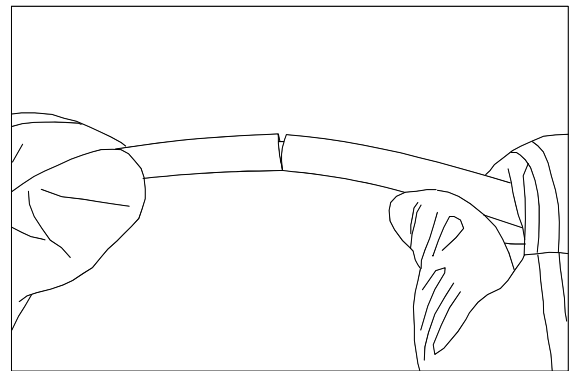

(Figure 4.2.b) Flex the cable at the ring cut

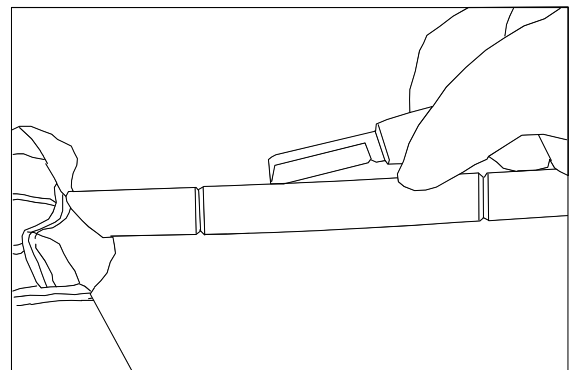

(Figure 4.2.c) Slit the sheath along the 3 to 5-inch section

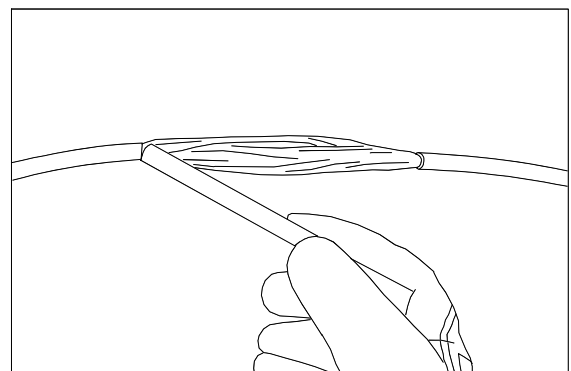

(Figure 4.2.d) Remove the sheath section

## 4.2b Armored Sheath Removal

Note: This section is written assuming a Single Armor/Single Jacket cable. If a multiple jacket /multiple armor cable is being accessed, this procedure will need to be repeated for each sheath.

Armored sheath removal is similar to dielectric sheath removal. Place tape markers 40 inches (100 cm) apart from each other on the cable section to be accessed. With the sheath knife, “ring” the circumference of the sheath at both marks, scoring the underlying steel armor as well. **DO NOT ATTEMPT TO CUT THROUGH THE ARMOR.**

At the center of this 40 inch section, measure and mark off a 3 to 5-inch (8-13cm) span of the outer sheath. “Ring” the cable with the sheath knife at each mark, again scoring the underlying armor. Gently flex the cable at these inner ring cuts to separate the sheath and armor.

Examine the edge of the armor at one of the ring cuts to find the armor seam or overlap. Using the sheath knife, peel away the sheath over the top of the overlap to expose the seam. Use the tip of the sheath knife to carefully pry open the armor, taking care not to damage the underlying tubes. Remove the armor and any remaining sheath and discard.

With the outer sheath removed, the ripcords and cable core are exposed. Cut the ripcords in the center of the exposed section.

Before pulling the ripcords, nick the armor with side cutters at the points where the ripcords disappear under the sheath. This gives a starting point for the ripcords to slit the armor

Grasp and wrap one of the ripcords around the needle nose pliers and pull back to back to the first outside ring cut. Do this in both directions. Repeat for the other ripcord and remove the split sheath from the cable.

If present cut the outer strength members at the center of the section and secure them away from the core.

Unwrap, cut, and discard the water absorbent tapes/yarns which are around the

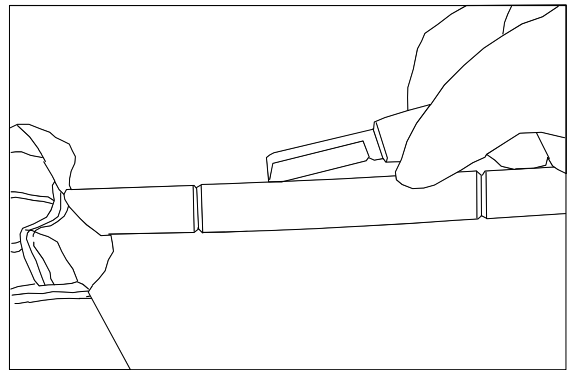

(Figure 4.2.e) Ring cuts 3 – 5 inches apart and flexed. Find armor overlap at ring cut, slit the sheath over top of the overlap and peel back

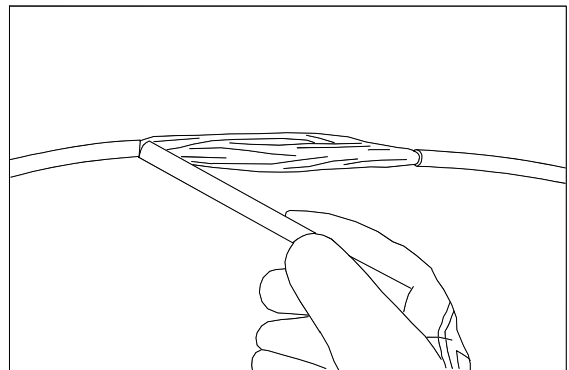

(Figure 4.2.f) Remove split cable sheath

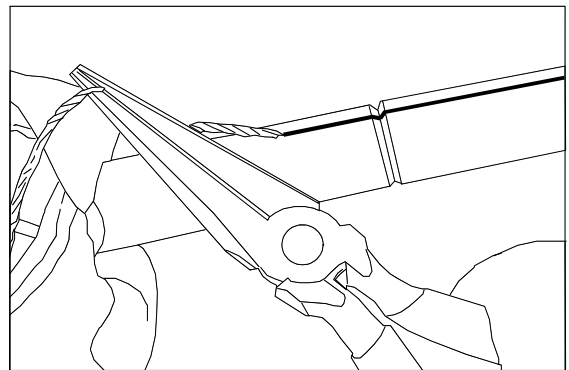

(Figure 4.2.g) Pull back ripcord to approximately 1 inch past ring cut to create grounding tab.

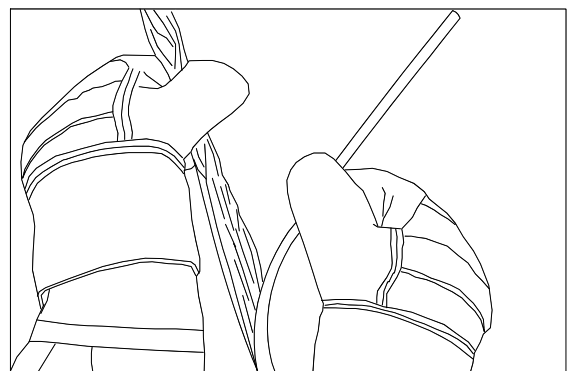

(Figure 4.2.h) Remove split cable sheath

buffer tubes. Leave the buffer tube binder strings and ripcords intact at this time. Locate the buffer tube reversal point by scanning the exposed cable core. The reversal must be centered in the full mid-span access length.

Repeat the previous steps to remove additional lengths of sheath, on either side of the reversal point, to expose the correct length of cable core. Ensure you refer to closure manufacturers' documentation for specific lengths to be accessed.

If the cable design is a multiple sheath cable (Single Armor/Double Jacket, Double Armor), the inner sheath(s) are removed in the same manner. Simply repeat the steps above.

### 4.3 Mid-Span Core Preparation

Cut, unwrap, and discard the buffer tube binder strings and any tape(s) not already removed.

Starting at the center reversal point (as described in step 4.1), unwind the color-coded buffer tubes one at a time from the central strength member. Remove any water absorbing tapes or yarns from around the central member and tubes.

Using approved cutters, cut the central strength member at both ends to the proper length for the type of closure being used.

The central member may be covered with a coating of plastic. This coating may be removed, if necessary, for a proper fit in the closure securing mechanism. To remove the coating, "ring" it with a sheath knife at the required distance from the end of the strength member. Do not cut into the underlying strength member. Using needle nose pliers, pull on the coating to separate it from the central strength member. It may be necessary to make a longitudinal cut in the coating from the ring cut to the end to facilitate the removal process.

If the cable contains tube placeholders, separate and cut them near the end of the cable sheath (placeholders are solid round plastic elements or hollow dummy tubes which do not contain fibers.)

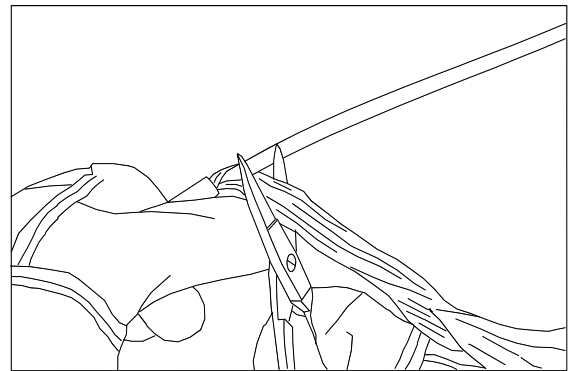

(Figure 4.2.i) Unwrap and cut outer strength members, water absorbent materials, and binders

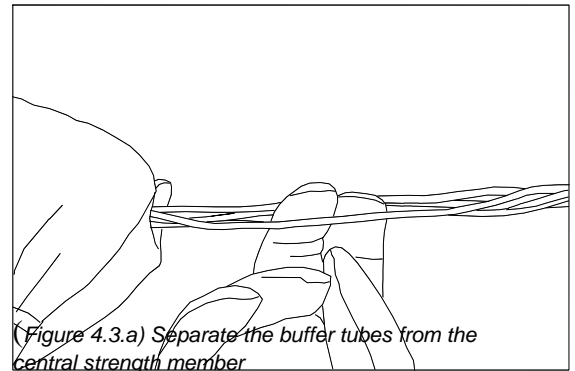

(Figure 4.3.a) Separate the buffer tubes from the central strength member

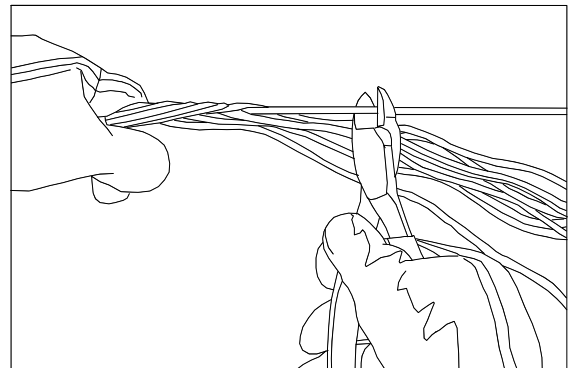

(Figure 4.3.b) Cutting the central strength member with cable cutters

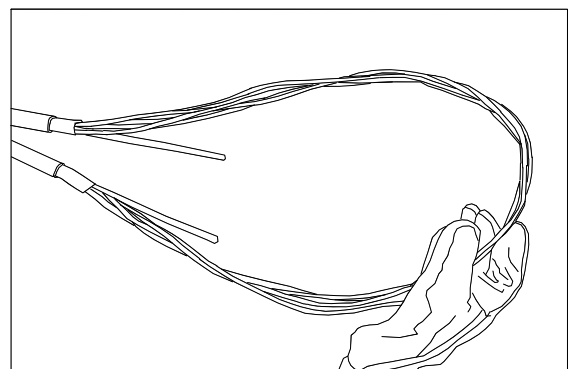

(Figure 4.3.c) Unwinding the buffer tubes

#### 4.4 Buffer Tube Preparation

Determine how many fibers or ribbons are to be accessed and in which tube(s) they reside. Mark the tube(s) and record this data for future reference. All other tubes may be left intact in the storage area of the closure or termination hardware.

NOTE: BECAUSE OF THEIR SIZE, RIBBON TUBES SHOULD NEVER BE COILED OR STORED SUCH THAT THEIR BEND DIAMETER IS LESS THAN SIX (6) INCHES.

Ensure that the Buffer Tube Access Tool is the proper size for the diameter of the tube. Commercial buffer tube slitters are compatible with Prysmian loose tube optical cable. A properly sized tool will open the tube without damaging the fiber or ribbons inside. See Prysmian MP-1005 (Procedure for Using Prysmian Buffer Tube Slitters).

Measure and mark the buffer tubes at the length to be removed. Use the Buffer Tube Slitter to carefully cut the buffer tube in between the two marks. With the buffer tube now slit, but still intact, final removal can take place.

Peel the small slit section of the tube away and cut at both ends. Remove the fiber or ribbons from the remaining split section of the tube. Cut the remaining section of the tube at both ends and remove. Repeat this procedure for each tube to be opened.

Gently wipe the excess thixotropic gel from the exposed fibers or ribbons with an approved lint free soft wipe.

#### 5.0 RIBBON CLEANING

If even cleaner ribbons are needed, then the following procedure should be used.

At no time during the cleaning operation should the ribbon be bent below its minimum bending radius. Do not wrap the ribbon around your finger.

Remove the bulk of the filling compound by wiping each ribbon individually with a lint free soft wipe

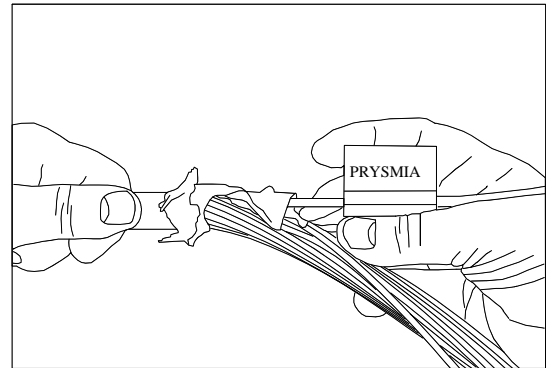

(Figure 4.4.a) Slit the buffer tube

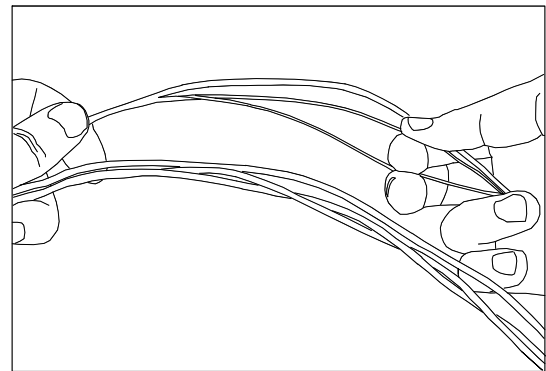

(Figure 4.4.b) Open the slit buffer tube and exposing the optical fibers or ribbons

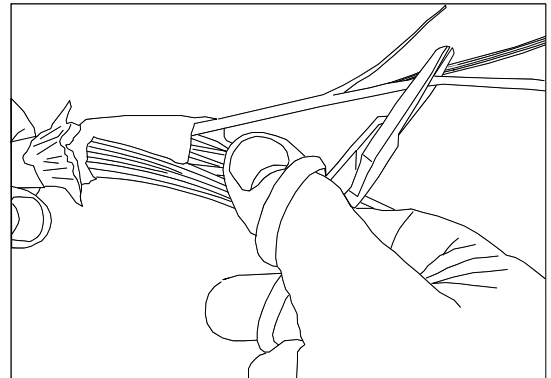

(Figure 4.4.c) Cut and remove the slit buffer tube

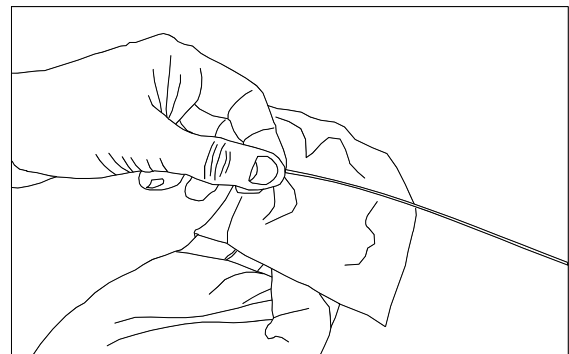

Figure 4.4.d) Wipe excess thixotropic gel from the fibers or ribbons

Soak a lint free soft wipe with filling compound remover and then wipe each ribbon twice using medium pressure.

Any residual filling compound should then be removed using dry lint free soft wipes

The use of Isopropyl Alcohol to remove filling compound is not recommended.

Always be sure to remove any left over solvent from the ribbons with a lint free soft wipe. Allowing ribbons to remain in contact with solvents for an extended time could potentially cause damage to the ribbon matrix or fiber coating

## 6.0 RIBBON PREPARATION

Prysmian's ribbon configured fiber consists of an array of color-coded optical fibers edge bonded together with a flexible matrix material. This matrix, along with the ink and fiber secondary coating, is easily removed by a variety of methods. Prysmian ribbon has been successfully stripped using mechanical, thermal, or a combination of these methods.

### 6.1a End Preparation: Thermal- Mechanical

If 12-fiber fusion splicing is required, use the thermal-mechanical or "Hot Jacket" strippers in conjunction with the mass fusion splicer. Follow the manufacturer's instructions for the unit(s) being used. Allow the unit to warm up completely on full power, then place the ribbon on the heating surface for 1-2 seconds before stripping.

Follow with a single wipe of an alcohol-dampened cloth to remove any residual debris.

If 12-fiber mechanical splicing is required, use the thermal-mechanical "Scissor Type" strippers, in conjunction with the mass mechanical splicing setup and follow the manufacturer's instructions.

Follow with a single wipe of an alcohol-dampened cloth to remove any residual debris.

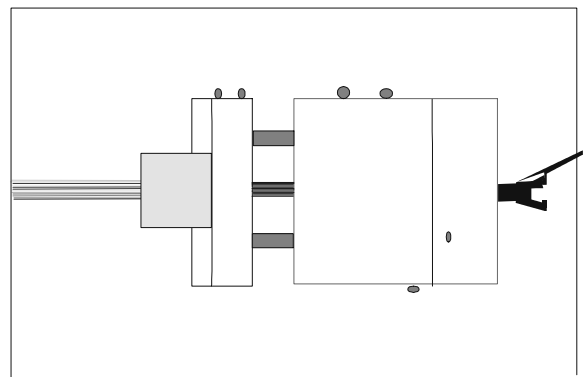

(Figure 6.1.a) Thermal-Mechanical (heat-stripping) a ribbon.

### 6.1b End Preparation: Mechanical

For applications requiring individual access to the fibers, Prysmian's ribbon can be separated simply by peeling the fibers away from each other. This method breaks the physical bond between the fibers but allows them to retain their color for identification.

Hold the ribbon to be stripped approximately one quarter of an inch from the end between the thumb and forefinger. Using the forefinger from the other hand, gently brush the fiber ends across the ribbon's major axis starting at one of the edge fibers. This action will separate the fibers at the tip of the ribbon.

To ensure that the fibers do not separate beyond the desired length, wrap a piece of tape around the ribbon at the desired endpoint. Hold the ribbon end between the thumb and index finger of one hand. With the thumb and index finger of the other hand, gently pull an edge fiber to slowly separate from the ribbon. Repeat this step for each fiber to be accessed.

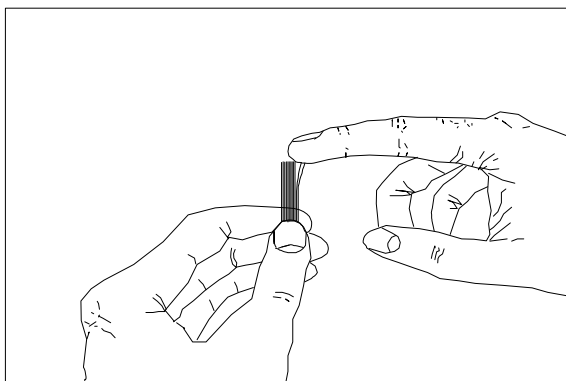

(Figure 6.1.b) Use the forefinger to separate the fibers from each other in the ribbon

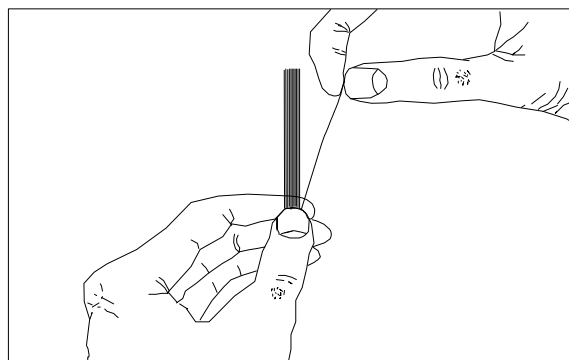

(Figure 6.1.c) Gently separate the fiber from the ribbon.

### 6.2 Mid-Span Preparation

To gain access to individual fibers within the ribbon matrix, Prysmian ribbon can be accessed mid-span using the commercially available method employing double-sided tape and super glue. Please refer to the manufacturer's instructions included with the ribbon mid-span access kit.

## 7.0 FIBER BUNDLE PREPARATION

Prysmian's bundled fiber configuration consists of groups of color-coded optical fibers bound together and positively identified by helically applied color-coded binder threads.

All fibers in Prysmian's bundled fiber designs are color coded to facilitate individual fiber identification. They follow the standard color coding sequence defined in TIA/EIA-359 standards.

Each optical fiber bundle contains up to 12 fibers. The binder colors follow the same color coding sequence as the fiber colors. For example, a blue binder binds the first bundle of fibers, and an orange binder binds the second bundle.

Once the fiber bundles have been exposed, select a binder thread from a bundle and carefully unwind it back towards the loose tube. At the loose tube gently tie the thread off on itself 2 – 3 times. This will prevent loss of bundle integrity during handling.

After tying off the first bundle's binder thread, carefully clip the thread off leaving an approximately  $\frac{1}{4}$ " –  $\frac{1}{2}$ " long tail. Move to the next bundle and unwind, tie and clip off its thread. Repeat these actions for each bundle within the loose tube.

Proceed to section 8 – Fiber Preparation, for instructions on how to prep each bundle's exposed fibers.

## 8.0 FIBER PREPARATION

Optical fibers are coated with an acrylate coating to protect the fiber. Using a fiber coating stripping tool, remove the coating from the fiber. Follow with a single wipe of an alcohol-dampened cloth to remove any residual debris.

Refer to local splicing and termination guidelines.

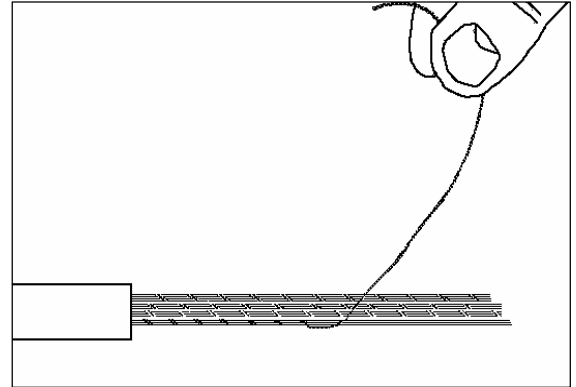

(Figure 7.0.a) Unwind the colored binder thread from around a fiber bundle

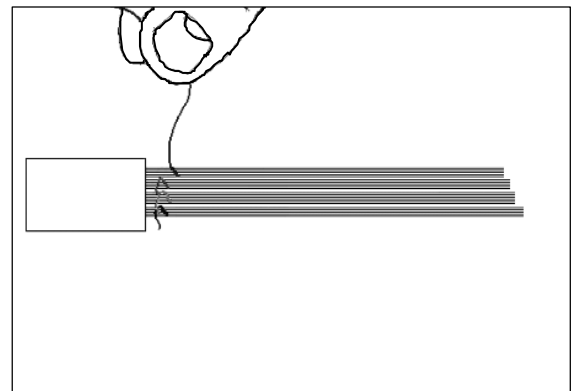

(Figure 7.0.b) Tie off a fiber bundle's colored binder thread

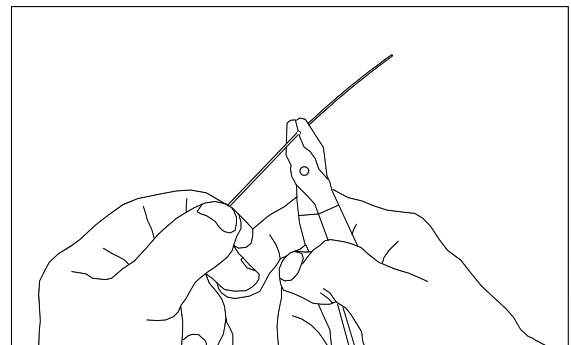

(Figure 8.0.a) Strip the primary coating from the fibers with stripping tool